



**MF90C**

**4G WI-FI HOTSPOT**

**USER MANUAL**

## CHECK YOUR SYSTEM REQUIREMENTS

Your 4G Wi-Fi hotspot will connect to any device that supports Wi-Fi, 802.11 b/g/n  
A web browser is required to log in to your Wi-Fi hotspot if you wish to make any configuration changes.

USB driverless connection is also supported for Windows, MAC and LINUX operating systems:

- Windows 8 (not including RT) / 7 / XP / Vista
- MAC OS X 10.5.11 and above
- Linux

Using the USB connection requires administrator rights to install and run the software.

We suggest you switch off your anti-virus software before connecting the hotspot

- In some cases protection software can prevent automatic installation.

It is possible to start the installation process manually by clicking the Autorun icon when it appears.

# GET TO KNOW YOUR 4G WI-FI HOTSPOT

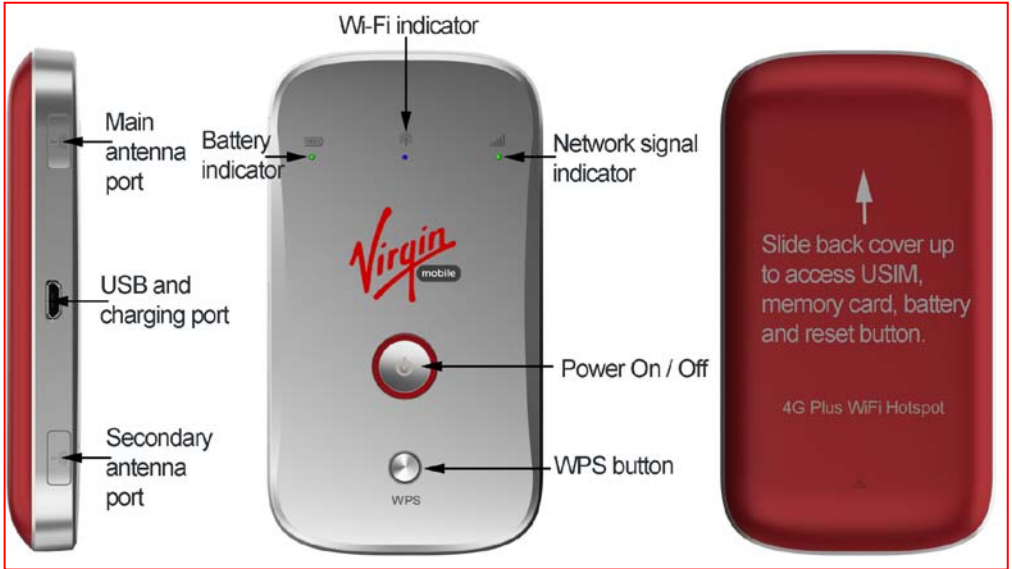

## INSERT YOUR USIM CARD

1. Slide the back cover up to access the USIM and memory card slots and the Reset button.
2. Insert your USIM card carefully as shown:

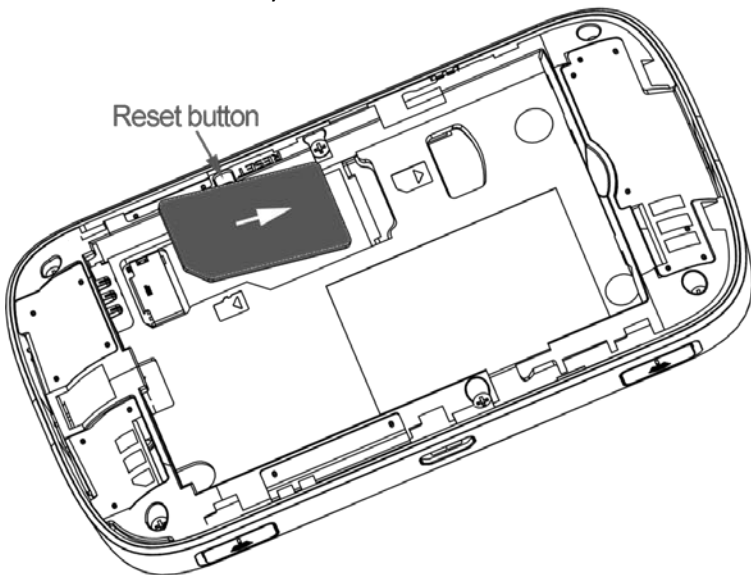

3. Insert the battery with the gold contacts lined up with the gold springs and slide the cover back on.
4. You are now ready to power up your device and you'll be on-line in no time.

### **IMPORTANT**

This device supports a standard mini SIM or 2FF size.

Do not insert a micro SIM (3FF) or use a micro to mini SIM adaptor.

Use of 3<sup>rd</sup> party adaptors or non approved SIM card can damage your device.

Physical damage to the SIM card slot is not covered by warranty and will make your device unusable.

### **TIP**

Remember to keep your plastic SIM card holder. It has a record of your SIM card which you should keep handy.

## **INSERT A MEMORY CARD (OPTIONAL)**

1. Your Wi-Fi hotspot supports up to 32GB microSD(HC)<sup>™</sup> memory, you can add a memory card to use for external storage and sharing files over your Wi-Fi network.
2. Insert the battery with the gold contacts lined up with the gold springs and slide the cover back on.
3. Use your memory card as external storage and share files to all your connected Wi-Fi devices. See SD CARD below for more information.

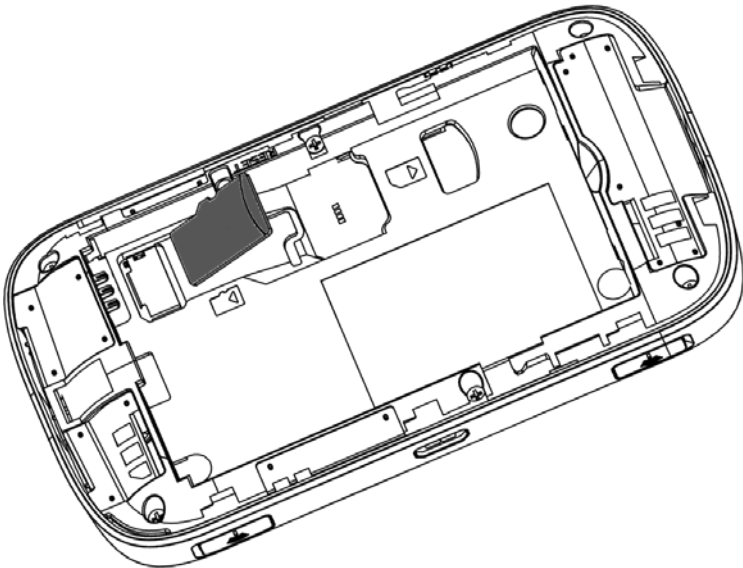

## Notes

- Adding a memory card is optional
- microSD™ up to 2GB are FAT 16 format.
- microSDHC™ up to 32GB are FAT 32 format.

## POWER UP YOUR 4G WI-FI HOTSPOT

Press and hold the Power key for 3-4 seconds until the lights flash.



















The LED's flash in sequence to indicate the start up condition. During this sequence the device functions are not available.

The Wi-Fi hotspot will be available after about 20 seconds.

**Note:** If you insert the charger with the device off, or the battery is flat, you can only power up the device after about 20 seconds when the start up sequence is complete.

Check the condition of your Wi-Fi hotspot as shown by the LED indicators.

## LED INDICATORS

	 	On, battery is low (<23%). Flashing, battery is discharged, (< 12 %).
	 	On, battery is OK (>23 %). Flashing, battery is charging.
	 	On, WPS is enabled, available for 2 minutes. Flashing, Wi-Fi is On.
		Off, Wi-Fi is off.
		Not registered on the network. No USIM, invalid USIM, PIN or PUK locked.
	 	On, device is registered on 2G/3G, Flashing, device is connected to 2G/3G.
	 	Device is registered on 4G Flashing, device is connected to 4G

During periods of inactivity it is normal for the LED's to go out to preserve battery life. Press the power key briefly to confirm the device status if required.

# CONNECT DEVICES BY WI-FI

Your 4G Wi-Fi hotspot can connect up to five devices via Wi-Fi providing internet access for all your devices on the go.

- On the devices you wish to connect make sure Wi-Fi is switched on, then search for Wi-Fi devices.
- The Wi-Fi hotspot will show up as Virgin Mobile 4G\_xxxxxx, click on this device to connect.
- Consult your SSID sticker and enter the default Wi-Fi key which is case sensitive. Any letters entered must be in upper case (capitals).

## Connection example for Windows 7 computer:

1. On your task bar, next to the clock, click on the Network Interface icon
2. Click on the Wireless device Virgin Mobile 4G\_xxxxxx
3. Enter the password exactly as shown on your SSID sticker observing the correct case for all letters
4. With Connect Automatically enabled your computer will remember the password and connect to your Wi-Fi device when it is on and in range.

### TIP

It is also possible to connect via USB connection. See later for details.

# MONITOR YOUR WI-FI HOTSPOT ON YOUR ANDROID DEVICE

You can download the ZTE Wi-Fi Monitor app from Google Play Store to monitor your Wi-Fi status easily using an Android smart phone.

## QUICK REFERENCES

Browser home page	http://192.168.0.1
Administrator login	Admin
Default SSID	Virgin Mobile 4G_xxxxxx Supplied on your SSID Sticker on the device and a spare sticker in the box.
Default Wi-Fi Key	10 characters which are case sensitive. Supplied on your SSID Sticker.

Restore defaults	<p>From the powered up state: Open the back cover and use a toothpick, paperclip or other suitable device to press and hold the “Reset” button for 5 seconds. All passwords and settings will be restored to defaults and the hotspot will reboot. Use the default credentials on your SSID sticker to log back onto your device.</p>
------------------	---

## LOGIN TO THE USER INTERFACE

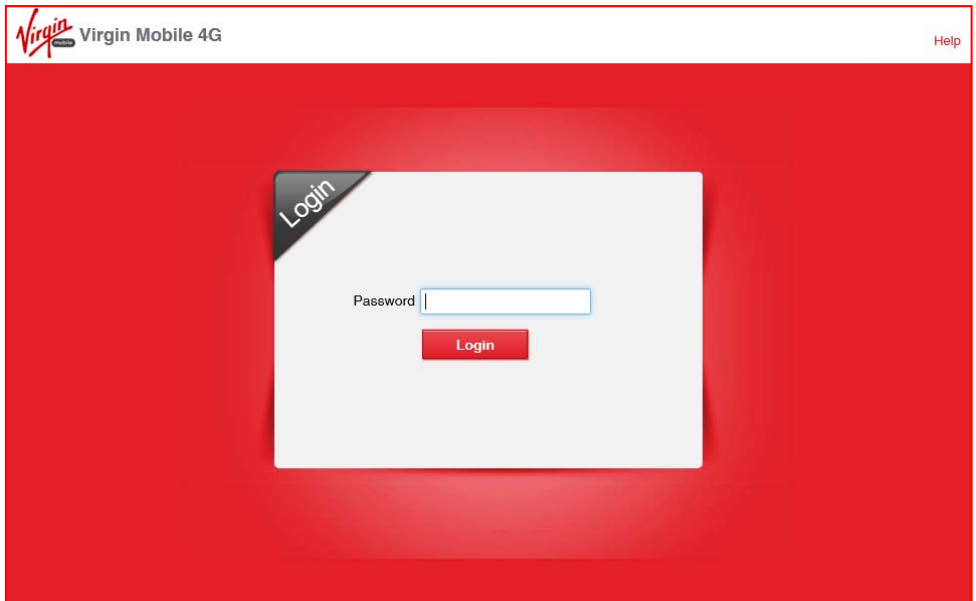

Open a browser and go to <http://192.168.0.1> to access the hotspot home page. The default login password is 'admin'





# INFORMATION > DEVICE INFORMATION

## Device Information

SIM Card Number	— —
IMEI	359734030115837
IMSI	505013403001442
Signal Strength	-86 dBm
Network Name (SSID)	Virgin Mobile 4G_02090D <a href="#">Change</a>
Max Access Number	5
Wi-Fi Performance	Long Wi-Fi Range <a href="#">Change</a>
LAN Domain	virginmobile4g.com
IP Address	192.168.0.1
MAC Address	6C:8B:2F:E8:74:66
WAN IP Address	10.96.45.104
Software Version	MF90C T01

- View the device IMEI number, Signal strength and other details.
- Press Change to set your own SSID name and to set the Wi-Fi performance (range) settings.
- The default setting is long range which give you better Wi-Fi performance over greater distances.
- **TIP:** If only using Wi-Fi over short distances, set Wi-Fi performance to Short Range to give better battery life

# INFORMATION > STATISTICS

**Statistics**

Upload		Download		
Speed	0B/s	0B/s		
	Duration	Downloaded	Uploaded	Total Used Data
Current Connection	00:00:00	0B	0B	0B
Current Month	03:27:54	30.74KB	27.55KB	58.29KB

[Clear](#)

 Data usage is approximate only. For actual usage, please refer to your network operator.

View your data usage on the Information > Statistics tab.

- Data usage is approximate and your carrier may charge you different data block sizes so their records and charges are likely to be different.
- Typical carrier data is charged in 1MB blocks.
- Contact your carrier for more details.

# DATA LIMIT SETTINGS

## Data Limit Settings

Data Use Limit  Enable  Disable

Limit by  Data  Time

Monthly \*

Remind me \*  %

[Apply](#)

 **?**

• Remind me when data/time use reaches specified percentage.

You can set a data limit reminder to let you know when you have reached a pre-set data usage limit.

- Example, Enter your monthly available data and set a Remind me at 80% to let you know when you are approaching your limit.
- Consult your carrier or contract details to determine your data allowance.

# SD CARD

## SD Card

Status **SD Card already exists and can be used now**

Mode  USB  HTTP SHARE

Share Setting  Enable  Disable

File to Share  Entire SD Card  Custom

Access Type  Read/Write  Read Only

Path to Share \*

Apply

**?**

- In HTTP Share Mode, the device only supports FAT file system!
- HTTP Share Mode: Share SD card via web browser. The removable drive mapping of SD card via USB port will be disabled.
- USB Access Only: By the removable drive mapping, user can access SD card via USB cable only. The web page of sharing SD card will be disabled.
- Path to Share: You can input the sharing path, such as /Picture. By typing only a slash in Path to Share filed, you agree to share entire SD card.
- Path to Share can't be a dot, and can't contain following characters: < > " ' & + / \ : \* | # ? ~ `

- If you have an SD card in your device you can share your files with other users connected to your device
- Enable HTTP Share to share the contents of your SD card with other Wi-Fi users connected to your device.
- Select USB Share to restrict access to USB mode only (like an external storage device)
- Read only or Read / Write access can be configured.
- Select Entire SD Card to share the whole card.
- Custom sharing can be enabled to restrict access to certain paths.
- Press the Web Share button to view all the files.
- Remember to press Apply to save your settings to enable SD sharing.

## SETTINGS > QUICK SETTINGS:

### Quick Settings

1. Quick Setup 2 3 4 5 6

Next

The wizard will show you how to set up gateway safely: Click "Next" to continue, click "Previous" & "Next" to navigate, and click "Apply" to save settings.

Set basic parameters in this wizard. For advanced parameters, set them in other menu.

Step through the Quick Settings wizard to quickly review your current default settings.

## SETTINGS > NETWORK SETTINGS > DIAL UP SETTINGS:

### Dial-up Settings

WAN Connection Mode  Automatic  
 Manual

Check here, you can connect to internet in the roaming status.

Disconnect Apply

**?**

- To change current setting, please disconnect from network.
- Automatic: The device will automatically connect to network when it is powered on.
- Manual: The device will connect to network manually.

- The default connection setting will automatically connect to the network. The setting is greyed out if you are connected.
- Press the Disconnect button to change this setting and to enable International Roaming if required.
- If you make any changes, press Apply to save the change
- Press the Help icon **?** to get in context tips.

# SETTINGS > NETWORK SETTINGS > NETWORK SELECTION:

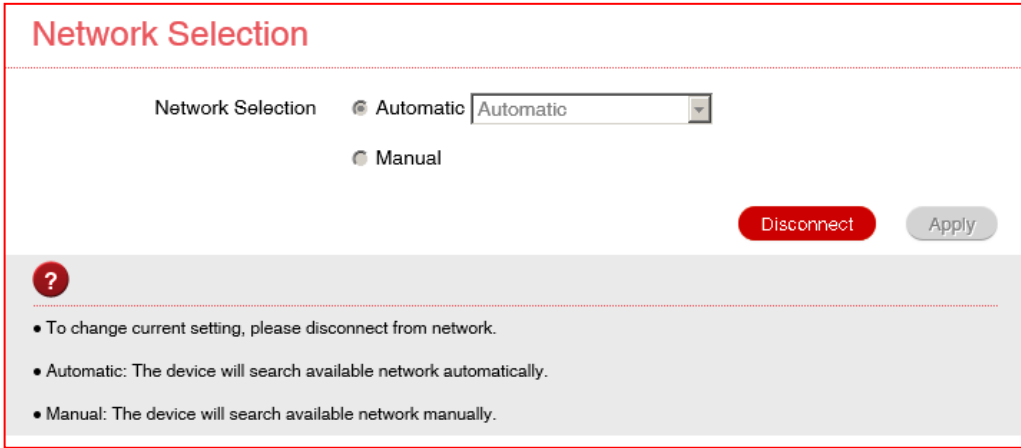

- Network Selection is set to Automatic. You can choose to lock to preferred network technologies such as 4G, 3G or 2G only.
- Press the Disconnect button to change this setting if required.
- If you make any changes, press Apply to save the change
- Press the Help icon  to get in context tips.
- Normally there is no need to change these settings.

## SETTINGS > APN:

### APN

Current APN Virgin Mobile

Mode  Auto  Manual

Profile

PDP Type

Profile Name \*

IPv4 APN \*

IPv4 Authentication

IPv4 User Name

IPv4 Password

---

**?**

- You can set the Access Point Name(APN) on this page.
- Profile: It contains one or more profile names.
- PDP Type: IPv4/IPv6/IPv4&IPv6.
- Profile Name: It refers to the name that you assign to the new profile.
- APN: Access Point Name. The APN contains 0-9 a-z A-Z . - and it can't start with and end with . or -.
- Authentication: It is provided by your Internet Service Provider(ISP). Password Authentication Protocol (PAP) provides a simple method without encryption for the peer to establish its identity using a 2-way handshake. Challenge-Handshake Authentication Protocol (CHAP) is used to periodically verify the identity of the peer using a 3-way handshake.
- User Name: User name is used to obtain authentication from the ISP when the connection is established.
- Password: Password is used to obtain authentication from the ISP when the connection is established.
- Click "Set as default" to set this profile as the default profile.

- Press the Disconnect button on the home page to change this setting if required.
- In Auto mode the device will provision the correct APN based on your SIM card and service provider.
- Press Add New to create a new APN
- Add the Profile Name, eg Virgin
- Enter the correct APN details eg virginbroadband
- Press Save to save your new APN
- Press the Profile drop down box
- Select the new APN profile

- Click on 'Set as default' to set the new APN as your preferred setting
- Press the Help icon  to get in context tips.
- Normally there is no need to change these settings unless you change service provider.
- The Wi-Fi hotspot is locked to Virgin. If you use a SIM card from another provider you may not be able to connect to the network.
- Consult your new carrier to obtain alternate APN details for your device.



# SETTINGS > WI-FI SETTINGS > BASIC SETTINGS

## Basic Settings

Network Name (SSID) \*

Broadcast Network Name (SSID)  Enable  Disable

Security Mode

Pass Phrase \*

Display Password

Max Station Number

**?**

- You can set the Wi-Fi basic characters on this page.
- Network Name: Service Set Identifier (SSID). Enter a string less than 32 characters as the name for your wireless local area network (WLAN).
- The network name contains 0-9 a-z A-Z ! # ( ) + - . / % = ? @ ^ \_ { | } ~ and space, and it can't start and end with space.
- Broadcast Network Name(SSID): Disable or Enable (Default) this function. Once enabled, the router will broadcast SSID, nd other devices can discover and connect to it.
- Security Mode:
  - OPEN: Authentication and encryption won't be performed. There are risks that private info will be intercepted or network will be used by unauthorized individuals. This encryption scheme isn't recommended.
  - WPA2(AES)-PSK: It is the secure version of WPA with implementation of the 802.11i standard.
  - WPA-PSK/WPA2-PSK: WPA Pre-Shared Key (WPA-PSK). WPA2-PSK is the secure version of WPA with implementation of the 802.11i standard.
- Pass Phrase: The pass-phrase contains 0-9 a-z A-Z ! # ( ) + - . / % = ? @ ^ \_ { | } ~
- Max Device Number: Choose the maximum number of devices connecting to AP.
- When clicking Apply, any connected Wi-Fi devices will need to reconnect.

- The SSID is the Wi-Fi name that is broadcast that represents your device:
- You can change the SSID to something more memorable or personal
- You can hide the SSID broadcast so unknown users will not even see your network
- You can change the security settings and password to suit your own preferences
- You can set the number of available connections between 1 and 10. The default setting for 5 users is to improve battery life and Wi-Fi data throughput.
- Press Apply to save your changes

## SETTINGS > WI-FI SETTINGS > ADVANCED

### Advanced Settings

Band Selection	2.4GHz
Network Mode	802.11 b/g/n
Channel Bandwidth	20MHz
Country/Region Code	AUSTRALIA
Frequency (Channel)	Auto

Apply



- You can set Wi-Fi advanced characters on this page.
- Band Selection: Select the band which is 2.4GHz or 5GHz.
- Network Mode: If all of the wireless devices are connected to this device in the same transmission mode, performance will be improved by selecting appropriate wireless mode.
- Country/Region Code: Select the right country code. When using the device internationally, please change the country/region code.
- Frequency (Channel): Select appropriate channel to optimize the performance and coverage of your wireless network.
- When clicking Apply, any connected Wi-Fi devices will need to reconnect.

- You can change the Wi-Fi settings to suit your personal choices or for specific requirements of your attached devices.
- Press Apply to save your changes

## SETTINGS > WI-FI SETTINGS > WPS

### WPS

WPS \*  PIN

PBC

Apply

**?**

- You can enable Wi-Fi Protected Setup(WPS) by PIN(PIN code) or PBC(push-button) mode on this page. If your client device supports WPS, there's no need to enter password manually when WPS is available.
- PIN: Enter PIN that is generated by wireless access client.
- PBC: Select PBC or press PBC button on the device.
- The device will wait for receiving the access request of wireless access client within 2 minutes.

- WPS uses the push button on the front panel to connect seamlessly to supported devices.
- Press WPS to enable, compatible devices can connect to your Wi-Fi network without authorisation, or you can set a PIN if required.
- WPS is enabled for 2 minutes once pressed and the device LED's will flash to indicate WPS mode.
- If you have enabled PIN mode then you need to enter the same PIN on devices you wish to connect.

# SETTINGS > DEVICE SETTINGS > ACCOUNT MANAGEMENT

## Account Management

Current Password \*

New Password \*

Confirm New Password \*

 ?

- You can change login password on this page.
- The password can't be empty and must contain at most 32 characters.
- The password contains 0-9 a-z A-Z!#\$%^&\*+,-.:%:=?@[ ]^\_{}~

- Use the Account Management settings to change the administrator password if required.
- The default password is admin. If you have changed and forgotten the password then you need to restore the device to factory defaults:
  1. With the device switched on open the back cover and locate the reset button on the left hand side.
  2. Using a blunt item such as a pencil, tooth pick or paperclip press and hold the “Reset” button for 5 seconds.
  3. The LEDs will flash and the device will re-boot to factory default settings.

## SETTINGS > DEVICE SETTINGS > PIN MANAGEMENT:

### PIN Management

PIN Status  Enable  Disable

Current PIN \*

Attempts Left: 2

**?**

- To change current setting, please disconnect from network.
- You can change PIN status and PIN code on this page.
- SIM card will be locked if you've continuously typed incorrect PIN 3 times. And you have to type PUK to unlock.
- PIN code and PUK code may be offered together with a SIM card. If not, contact your operator. Please change default PIN code as soon as possible.

- Press the Disconnect button on the home page to change the PIN settings if required.
- Enter your current SIM PIN code to change or disable the PIN.
- If you make any changes, press Apply to save the change.
- If you enter the incorrect PIN code three times in succession you will lock your USIM card.
- Contact your service provider to obtain your PUK code.

## SETTINGS > DEVICE SETTINGS > RESET

Press **Reset** to restore your original factory settings.

## SETTINGS > DEVICE SETTINGS > RESTART

Press **Restart** to power cycle your device.

# SETTINGS > DEVICE SETTINGS > POWER SAVE

## Wi-Fi Performance Settings

- Wi-Fi Performance
- Short Wi-Fi Range - Best battery life
  - Medium Wi-Fi Range
  - Long Wi-Fi Range

Apply



- Battery life varies with Wi-Fi range and sleep time.
- Wi-Fi Range:
  - Short Wi-Fi Range: Increases battery life.
  - Medium Wi-Fi Range: Intermediate battery life and Wi-Fi range.
  - Long Wi-Fi Range: Extend coverage of mobile hotspot and still connect to your Wi-Fi network, which will decrease battery life.

## Wi-Fi Sleep Settings

Sleep Time

Apply



- Sleep Time: When there's no Wi-Fi connection in specific time, Wi-Fi will be unavailable, and the system will turn to sleep mode for power-saving.

- The default setting provides the greatest reach for your Wi-Fi signal.
- Setting to Short Range will preserve battery life by reducing the Wi-Fi power.
- If there is no Wi-Fi traffic detected then the device will switch off Wi-Fi as determined by the Wi-Fi sleep setting.
- Set Wi-Fi sleep time to Never Sleep to keep the Wi-Fi always on.

## SETTINGS > DEVICE SETTINGS > UPDATE MANAGEMENT

- You need to be in the Connected state to check for new versions
- Press the Check button to see if there are software updates for your device.
- Roaming Settings control if the device will update when roaming. This is disabled to reduce high data charges when roaming.

# SETTINGS > FIREWALL > PORT FILTERING

## Port Filtering

MAC/IP/Port Filtering  Enable  Disable

Default Policy  Accepted  Dropped

Apply



- You can set firewall policies to protect your network from viruses, worms and malicious activities on the Internet.
- Only when filtering is enabled, the filter policy is available.

## MAC/IP/Port Filtering Settings

IP Settings  IPv4  IPv6

MAC Address  (e.g., 00:1E:90:FF:FF:FF)

Source IP Address

Dest. IP Address

Protocol

Action  Accept  Drop

Comment

Apply



- MAC Address: Set MAC address to be filtered.
- Source IP Address: Set source IP address to be filtered.
- Dest IP Address: Set dest IP address to be filtered.
- Protocol: Set protocol to be used for filtering.
- Source Port Range: Set source port numbers to be filtered.
- Dest Port Range: Set dest port numbers to be filtered.
- Action: Set to handle the packet if it matches with the rule.
- Comment: Enter comment for filter settings. It contains 0-9 a-z A-Z ! # ( ) + - . / % = ? @ ^ \_ { | } ~ .
- The filter policies are matched one by one with the rules. And if met this provision, it won't continue to match the rules listed below.
- The maximum of rules for IPv4 and IPv6 is 10 respectively.

## Current MAC/IP/Port filtering rules in system

<input type="checkbox"/>	MAC Address	IP Type	Source IP Address	Dest. IP Address	Protocol	Source
--------------------------	-------------	---------	-------------------	------------------	----------	--------

Delete



- Others would be accepted.



- Select Enable to turn on the Port Filtering settings
- You can apply filters based on MAC Address, Source IP Address, Destination IP Address and select the action to drop or accept the packets.
- Firewall settings are for advanced users and network administrators.
- Press the Help icon  to get in context tips.

## SETTINGS > FIREWALL > PORT FORWARDING

### Port Forwarding

Virtual Server Settings  Enable  Disable Apply

### Virtual Server Settings

Src. Port \*  (1~65000)

Dest. IP Address \*  (e.g., 192.168.0.101)

Dest. Port \*  (1~65000)

Protocol  ▼

Comment \*

Apply



- The maximum number of rules is 10.

### Current Virtual Servers in system

	Src. Port	Dest. IP Address	Dest. Port	Protocol	Comment
<input type="checkbox"/>					

Delete

- Select Enable to turn on the port forwarding settings.
- Port forwarding can be used to allow a specific external server or computer access to devices located on your LAN side or to translate a specific incoming port into a different destination port.
- The destination port and address is on your local LAN side.
- Typical applications will be for multi party gaming, requiring specific control and

communications channels between the remote server and the local machine.

- Firewall settings are for advanced users and network administrators.
- Press the Help icon  to get in context tips.

## SETTINGS > FIREWALL > SYSTEM SECURITY

- Enable or Disable Remote Management (via WAN) and PING
- Firewall settings are for advanced users and network administrators.

## SETTINGS > FIREWALL > UPNP

- Universal Plug and Play is a set of networking protocols that permits networked devices, such as personal computers, printers, Internet gateways, Wi-Fi access points and mobile devices to seamlessly discover each other's presence on the network and establish functional network services for data sharing, communications, and entertainment.
- UPnP is enabled by default on the LAN side (local) but if you require extra security you should disable this setting.
- UPnP is not enabled on the WAN (Network) side.
- Firewall settings are for advanced users and network administrators.

## SETTINGS > FIREWALL > DMZ

- Enable the DMZ Setting to open up all ports from the WAN side (mobile network) to the LAN side for this particular allocated IP address.
- It is advisable to set a Static IP address for this device outside of the DHCP range eg 192.168.0.20

# SETTINGS > ROUTER SETTINGS

## Router Settings

IP Address \*

Subnet Mask \*

DHCP Server  Enable  Disable

DHCP IP Pool \*  -

DHCP Lease Time \*  hour(s)

Apply

Cancel



- uFi is set as a Dynamic Host Configuration Protocol (DHCP) server by default, providing IP address from DHCP IP Pool for all PC connections to LAN.
- IP Address: IP address for LAN interface.
- Subnet Mask: Subnet mask for IP address.
- DHCP Server: Enable or disable DHCP Server.
- DHCP IP Pool: Allocate start and end IP address for IP pool.
- DHCP Lease Time: Define validity of the leased IP address; and new IP address will be relocated .
- Your settings will take effect after restarting your device.

# SETTINGS > INTERNET WI-FI

## Internet Wi-Fi

Internet Wi-Fi Switch  Enable  Disable

Current Status **WAN connected**

Apply

## Wi-Fi Hotspot

Connect Delete Edit Add

Option	SSID	Signal	Security Mode
<p><b>?</b></p> <ul style="list-style-type: none"><li>Please make sure that the IP address of Wi-Fi hotspot you've connected isn't in the range of this device IP address, or you won't have access to Internet via the Wi-Fi hotspot.</li></ul>			

- Enable Internet Wi-Fi to share the data connection from another existing Wi-Fi hotspot.
- This feature will re-broadcast another Wi-Fi hotspot to your connected devices and divert all data traffic to the other Wi-Fi hotspot.

# USB INSTALLATION FOR TETHERED CONNECTION

You can also connect to your Wi-Fi hotspot using the USB lead provided.

- The installation software is pre-loaded on your device.
- Simply insert the Wi-Fi hotspot into your computer and follow the instructions on-screen.

Example shown for Windows operating system.

1. Click on 'Open folder...'

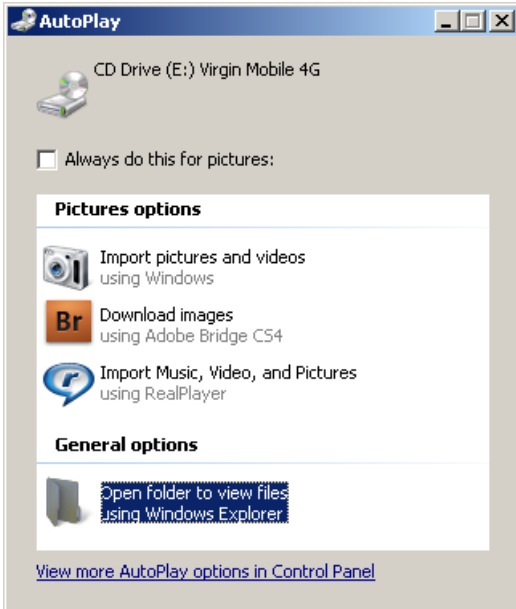

2. Double click Autorun.exe

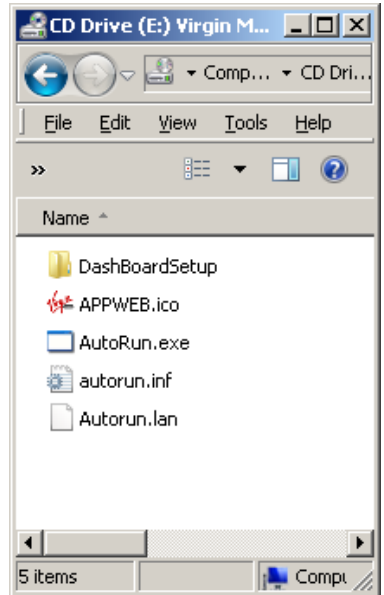

3. The installation will create a short-cut on your desktop and open your browser at the device homepage.

## USB INSTALLATION NOTES

- The installation will create a new shortcut on your desktop and a new program listing under Start-Programs
- If you have problems with the installation please contact your supplier or see our website, [zte.com.au/virgin](http://zte.com.au/virgin) for more assistance and FAQ's or call our hotline on 1300 789 475 available between 9am and 5pm AEST.
- If you can't connect to the internet check your SIM card is inserted correctly, contact your service provider and check your account is active.

- To uninstall the application:  
Windows users: Programs > Virgin Mobile 4G > Uninstall

#### **MAC Users:**

- Double click the CD Drive Virgin Mobile 4G on the desktop to install the software.
- To uninstall, go to Applications and run Uninstall Virgin Mobile 4G

## HELP

- Click Help button to access this full user guide
- Click the Help icon  to see in context help
- Go to [zte.com.au/virgin](http://zte.com.au/virgin) for FAQ's, product and warranty support

## microSD™ MEMORY CARD

If you use a microSD™ memory card in your device your computer will display a removable disk drive when connected via USB. You can use the device as an external drive to store and transfer files.

microSD™ cards supported to 2GB are FAT 16 format.

microSDHC™ cards supported to 32GB are FAT 32 format.

If using a memory card use the Safe Removal of Hardware process or Eject the device. Consult your operating system guidelines.

## USING EXTERNAL ANTENNA(S)

Your 4G Wi-Fi hotspot has two external antenna ports for 4G LTE MiMo (Multiple input, Multiple output) Networks. Network signal and data rates can be improved by connecting a dual (2x2) antenna.

If you are using a single antenna then connect to the Main antenna port at the top of the device.

The antenna connection is TS9 and dual and single antennas are available on line or from major retailers.

**Important Note:** Always take care when connecting an external antenna or patch lead.

Using incorrect connectors may damage your device.

Do not trip over or pull harshly on the antenna cable which may damage the antenna port connector.

Physical damage to the antenna ports is not covered by warranty and may permanently damage your device.

## NOTES FOR BATTERY CHARGING

The internal battery will last up to four hours in normal use but this is dependant on many factors such as network signal strength, number of users connected and the amount of data being transferred.

Battery time will reduce when the network signal is low, many Wi-Fi users are connected or users are engaged in continuous data downloads or uploads (ie streaming video, audio or FTP traffic).

It is normal for the device to get hot when the network signal is low and users are engaged in continuous data traffic.

If the device temperature exceeds 45C then the battery will not be charged. This is a safety feature required for Lithium-ion batteries.

In these cases it is possible for the battery to discharge, even though the device is connected to the charger.

# TROUBLESHOOTING

If you have any problems with your connection or Wi-Fi hotspot please consult the manual and check this section.

If the problem still exists contact your service provider or check our website for more details at [zte.com.au/virgin](http://zte.com.au/virgin)

Problem	Possible Causes	Suggested Solution
I cannot connect via Wi-Fi	Security settings, password has been changed.	Check the security settings SSID and Password shown on your Security Card. If the password has been changed reset the hotspot to factory defaults: 1. With the device switched on open the back cover and locate the reset button on the left hand side. 2. Using a blunt item such as a pencil, tooth pick or paperclip press and hold the "Reset" button for 5 seconds. 3. The LEDs will flash and the device will re-boot to factory default settings.
The user interface doesn't start after the Wi-Fi hotspot is plugged in.	PC configuration is not correct. (No autorun)	Start the program manually by going Start > Program Files or use the shortcut on the desktop.
The Wi-Fi hotspot has no signal.	You have no network coverage.	Try moving location until you get good reception.
SIM Card is locked	SIM card requires a PIN or PUK number.	Contact your service provider to obtain the PIN or PUK key.
Data connection failed.	You have no network coverage.	Try moving location until you get good reception.



<b>Problem</b>	<b>Possible Causes</b>	<b>Suggested Solution</b>
The Wi-Fi hotspot cannot connect to the internet when overseas	You don't have international roaming enabled on your plan.	Consult your service provider before you go overseas to enable roaming.
The microSD™ card cannot be read or is not found.	Re-insert the microSD™ card. The maximum capacity is 32GB SDHC card	Try another microSD™ card and make sure the capacity and format is correct.
Where can I get more help and technical support?	If you get really stuck, we are on hand to help	Consult the manufacturer's website at <a href="http://zte.com.au/virgin">zte.com.au/virgin</a> or call 1300 789 475 for full technical support during office hours, Mon – Fri 9am to 5pm AEST.

## PRECAUTIONS AND SAFETY INFORMATION

- Some electronic devices are susceptible to electromagnetic interference. The Wi-Fi hotspot is a transmitting device and may cause interference to sensitive electronic equipment such as audio systems, vehicle systems and medical equipment. Please consult the manufacturer of the other device before using the Wi-Fi hotspot.
- Operating the Wi-Fi hotspot may interfere with medical devices like hearing aids and pacemakers. Please keep the Wi-Fi hotspot more than 20 centimetres away from such medical devices. Turn the Wi-Fi hotspot off if necessary. Consult a physician or the manufacturer of the medical device before using the Wi-Fi hotspot near such devices.
- Be aware of regulations when using the Wi-Fi hotspot at places such as oil refineries or chemical factories, where there are explosive gases or explosive products being processed. Turn off your Wi-Fi hotspot as instructed.
- Don't touch the antenna area unnecessarily whilst connected. This can affect your Wi-Fi hotspot performance and reduce the signal quality.
- Store the Wi-Fi hotspot out of the reach of children. The Wi-Fi hotspot may cause injury or get damaged.
- The Wi-Fi hotspot contains sensitive electronic circuitry. Do not expose the Wi-Fi hotspot to any liquids, high temperatures or shock.
- Only use original accessories or accessories that are authorised by the manufacturer. Using unauthorised accessories may affect your Wi-Fi hotspot's

performance or damage your Wi-Fi hotspot.

- Avoid using the Wi-Fi hotspot in areas that emit electromagnetic waves or in enclosed metallic structures eg lifts.
- The Wi-Fi hotspot is not waterproof. Please keep it dry and store it in a cool, dry place.
- Don't use the Wi-Fi hotspot immediately after a sudden temperature change eg from an air conditioned environment to high temperature and humidity outside. In such cases there could be condensing moisture inside the Wi-Fi hotspot which can cause internal damage. Unplug the Wi-Fi hotspot and leave it for 30 minutes before use.
- Always handle the Wi-Fi hotspot with care. Be careful not to drop or bend the device.
- There are no user serviceable parts. Unauthorised dismantling or repair will void the warranty.
- The battery will not be charged above 45C.

## RF SAFETY INFORMATION

The wireless device has an internal antenna. For optimum performance with minimum power consumption do not shield the device or cover with any object. Covering the antenna affects signal quality and may cause the Wi-Fi hotspot to operate at a higher power level than needed.

## RADIO FREQUENCY ENERGY

The wireless device is a low-power radio transmitter and receiver. When switched on it intermittently transmits radio frequency (RF) energy (radio waves).

The transmit power level is optimized for best performance and automatically reduces when there is good quality reception.

Maximum power is only used at the edge of network coverage so under most circumstances the power output is very low.

Under poor network conditions the Wi-Fi hotspot transmits at a higher power level and may get hot.

## SPECIFIC ABSORPTION RATE (SAR)

The wireless device is designed to be used in close proximity to the body. We declare that the product detailed in this manual, and in combination with our

accessories, conform with the essential requirements of The Radio Communications Standard (Electromagnetic Radiation Human Exposure) 2003 and the Australian Communications and Media Authority Section 376 of the Telecommunications Act 1997 when used at a distance of not less than 5mm from the body. The worst case SAR result is published on the manufacturer's website at [zte.com.au/virgin](http://zte.com.au/virgin)



N14945

## TECHNICAL SPECIFICATIONS

Network compatibility	4G LTE FDD: 1800, 2600 4G LTE TDD: 2300 MHz 3G UMTS: 900, 2100 MHz GSM: 900, 1800, 1900 MHz
Dimensions	106 x 58 x 15.8mm. Approx 103g
Data Rates*	4G FDD download speeds up to 100Mbps 4G TDD download speeds up to 81Mbps 3G DC-HSPA+ Mode up to 42Mbps
External Antenna	Dual external antenna supports TS9 connector
Voltage	5V
Current	Resting: 100mA rms Max: 500mA rms
Operating systems	Windows 8 (not RT), 7, XP SP3, Vista MAC OS X 10.5 and above
Memory card	Up to 32GB microSDHC™
Operating temperature	-5°C to +45°C
Battery capacity	2300mAh
Charge time	Up to 3 hours with charger, up to 6 hours via USB
Standby time**	Up to 100 hours
Operation time**	Up to 4 hours use

\* Download speeds will vary due to distance from the cell, local conditions, user numbers, file source, hardware, software and other factors.

\*\* Operation and Standby times depend on a number of conditions and are measured in ideal conditions.

**ZTE** Copyright © 2013. All rights reserved.

No part of this publication may be excerpted, reproduced, translated or utilized in any form or by any means, electronic or mechanical, including photocopying and microfilm, without the prior written permission of ZTE Corporation.

The manual is published by ZTE Corporation. We reserve the right to make modifications on errors or update specifications without prior notice.

Version 2.1      December 2013